



Type 0340 can be combined with...



Type 2508

Cable plug

3/2-way solenoid valve for gases and fluids

- Service friendly manual override
- Analytical pilot valve for increased safety
- Optimized piston design for low switching pressure
- Energy saving impulse coil
- Explosion proof types

The pilot-controlled 3/2-way solenoid valve Type 0340 with smoothly operating servopiston requires a differential pressure of 0.5 bar for complete opening and closing. A 3/2-way pilot valve (pivoted armature valve) ensures safe and reliable operation.

Circuit function C

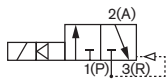

3/2-way valve, when de-energized outlet port A exhausted, with 3-way pilot control

Circuit function D

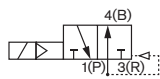

3/2-way valve, when de-energized outlet port B pressurized, with 3-way pilot control

Circuit function C (Impulse)

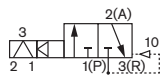

3/2-way valve, when de-energized outlet port A exhausted, with 3-way pilot control

Circuit function D (Impulse)

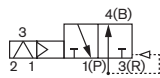

3/2-way valve, when de-energized outlet port B pressurized, with 3-way pilot control

Technical data

Orifice	DN 8 - 40 mm
Body material	Brass
Seal material	NBR
Medium	Neutral medium: Compressed air, water, hydraulic oil
Medium temperature	0 to +90 °C
Ambient temperature	Max. +55 °C
Viscosity	Max. 21 mm ² /s
Voltage tolerance	±10%
Duty cycle	Continuous operation 100% ED
Electrical connection	Cable plug for Ø 7 mm cable (included in delivery) Ex-Version only with terminal box or 3 m cable
Protection class	IP65 with Cable Plug or terminal box
Installation	As required, preferably with actuator upright

Flow rate Kv value water [m ³ /h]	measured at +20 °C, 1 bar pressure at valve inlet and free outlet (see ordering chart)
Pressure values [bar]	Overpressure to the atmospheric pressure (see ordering chart)
Response times [ms]: Opening Closing	Measured at valve outlet at 6 bar and +20 °C Pressure rise 0 to 90%, Pressure drop 100 to 10% (see ordering chart)

Technical data

Standard version

Orifice [mm]	Kv value water PDA [m³/h]	Port connection A/B and P		Pressure range [bar]	Electr. power consumption				Response times		Weight [kg]
		G	NPT		Inrush AC [VA]	DC [W]	[VA] AC [VA/W]	DC [W]	Opening [ms]	Closing [ms]	
8	0,95	1/4	1/4	0,5 - 16	30	8	15/8	8	25	25	1,0
12	2,30	3/8	3/8						30	30	1,2
12	2,60	1/2	1/2						30	30	1,2
20	6,60	3/4	3/4						40	40	2,2
40	24,00	1 1/2	1 1/2						120	120	6,8

Impulse version

Orifice [mm]	Kv value water PDA [m³/h]	Port connection A/B and P		Pressure range [bar]	Electr. power consumption		Response times		Weight [kg]
		G	NPT		Inrush AC [VA]	DC [W]	Opening [ms]	Closing [ms]	
8	0,95	1/4	1/4	0,5 - 16	11	11	25	25	1,0
12	2,30	3/8	3/8				30	30	1,2
12	2,60	1/2	1/2				30	30	1,2
20	6,60	3/4	3/4				40	40	2,2
40	24,00	1 1/2	1 1/2				120	120	6,8

Explosion proofed version with temperature class T5

Orifice [mm]	Kv value water PDA [m³/h]	Port connection A/B and P		Pressure range [bar]	Electr. power consumption		Response times		Weight [kg]
		G	NPT		Inrush AC [VA]	[VA] AC [VA/W]	Opening [ms]	Closing [ms]	
8	0,95	1/4	1/4	0,5 - 16	40	3	25	25	1,0
12	2,30	3/8	3/8				30	30	1,2
12	2,60	1/2	1/2				30	30	1,2
20	6,60	3/4	3/4				40	40	2,2
25	10,00	1	1	0,5 - 10			70	70	2,7

The orifice size of connection R is larger than the ports A / B and P (see table of dimensions). Thus, the AR flow rate increases by a factor of 1.5 to 2 in the table value.

Material

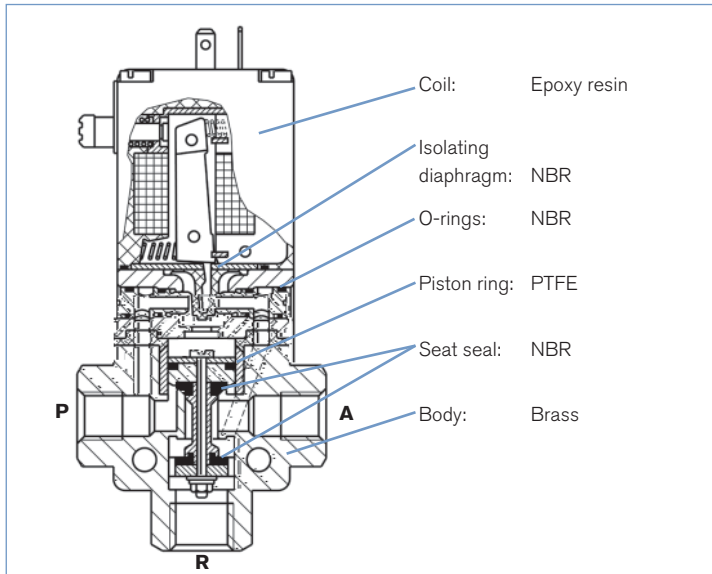

Dimensions [mm] - Standard version

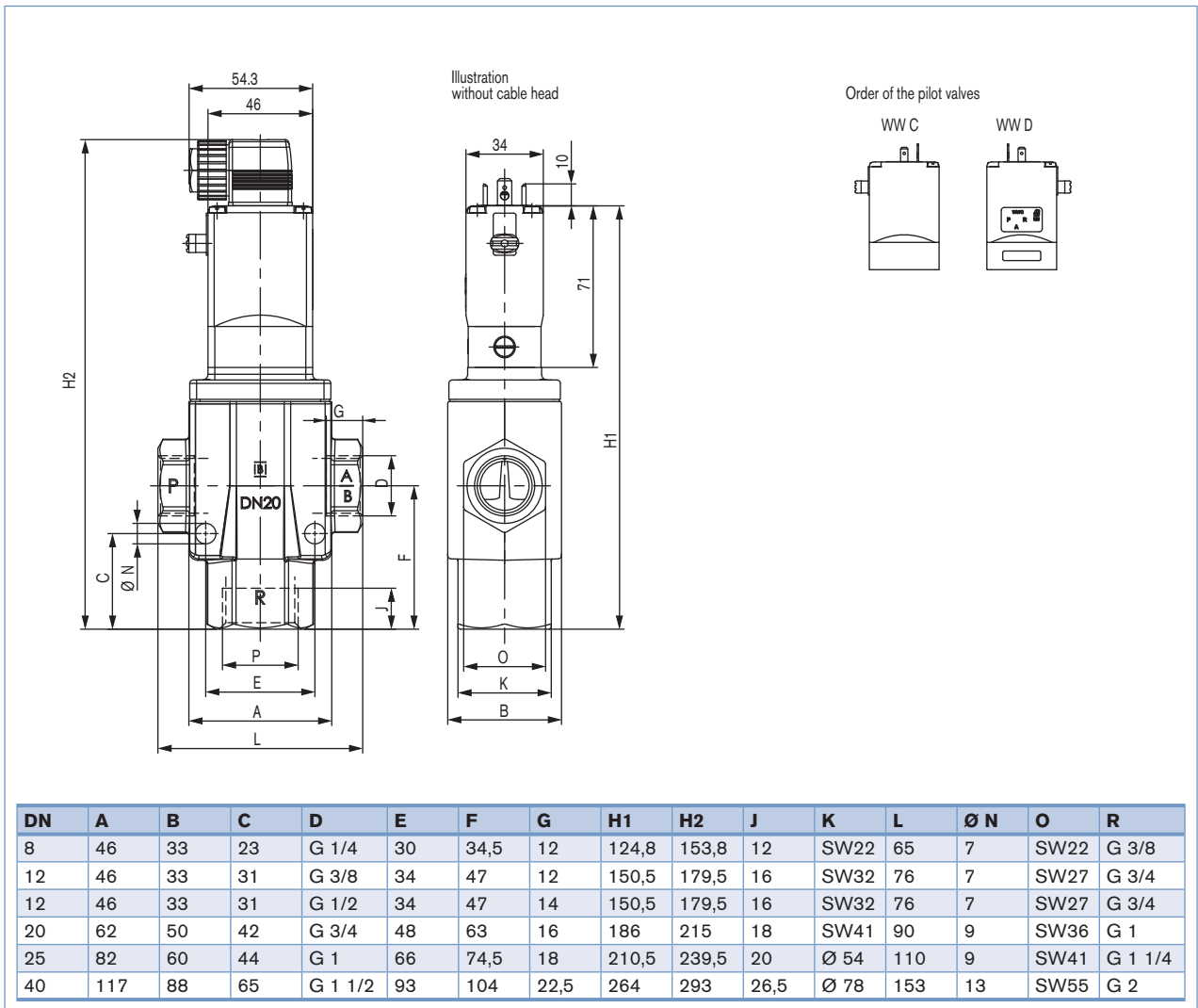

The diagram shows the valve with circuit function C with the terminals P, R and A / B. (see drawing). In circuit function D the manual operation is above port A / B.

Dimensions [mm] - Explosion proof version

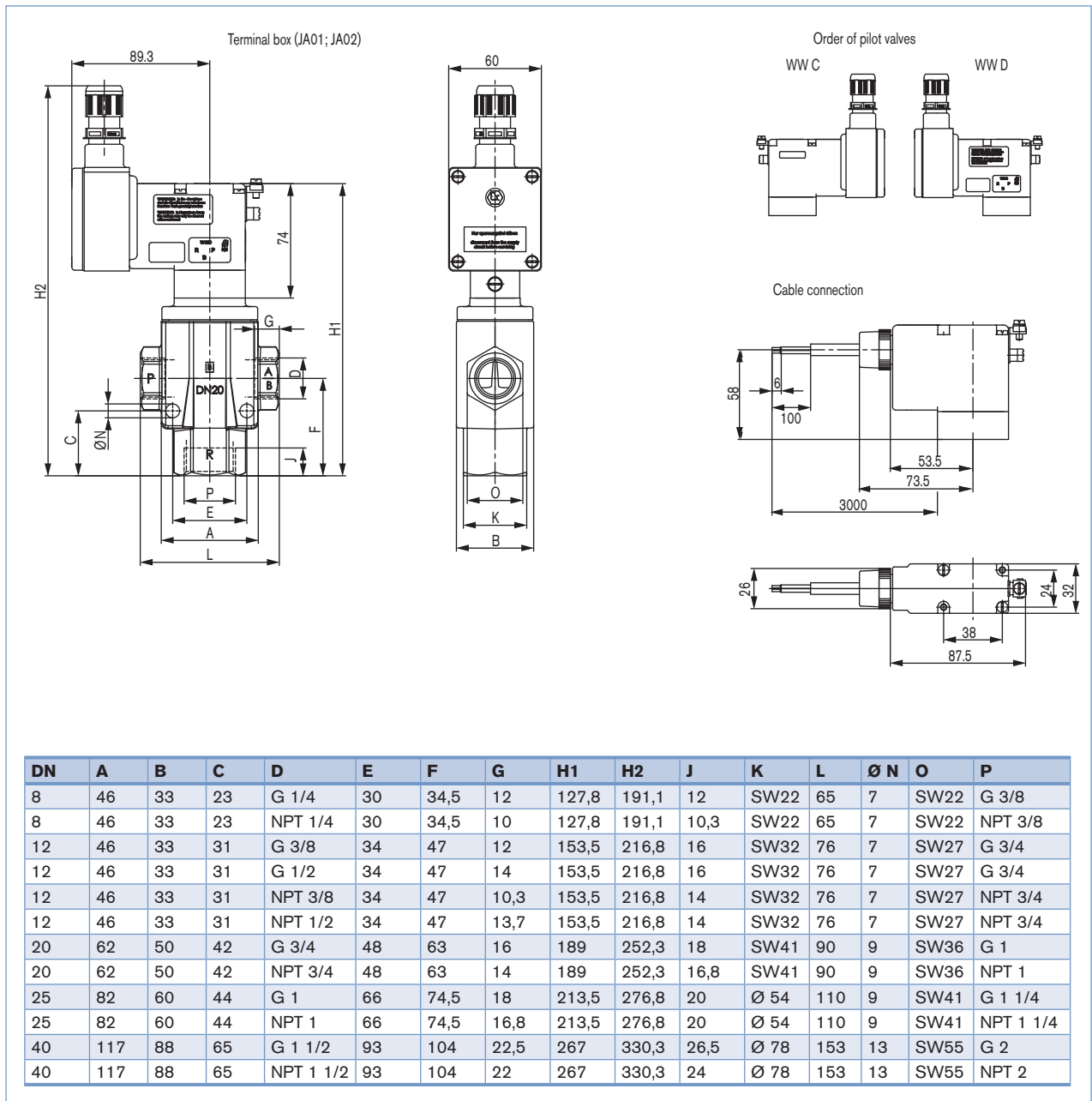

Ordering charts standard version (other versions on request)

All valves with manual override, brass body, NBR seal and cable plug

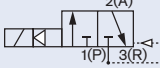
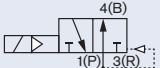
Circuit functions	Orifice [mm]	Port connection G or NPT	Kv value water P→A [m³/h]	Pressure range [bar]	Voltage/Frequency [V/Hz]	Item no. G	Item no. NPT
C A 3/2-way valve NC 	8,0	1/4	0,95	0,5 - 16	012/DC	042 506	x
					024/DC	041 317	x
					024/50	041 318	x
					110/50	041 325	x
					230/50	041 329	x
					024/50	041 351	x
	12	3/8	2,3	0,5 - 16	230/50	041 353	x
					024/DC	041 333	x
					024/50	041 334	151 477
					110/50	041 340	x
					230/50	041 346	x
					240/50	042 277	x
	20	3/4	6,6	0,5 - 16	024/DC	041 354	x
					024/50	041 665	x
					110/50	041 359	125 822
					230/50	041 361	x
024/DC					041 537	x	
110/50					042 864	120 389	
25	1	10,0	0,5 - 10	230/50	041 364	x	
				024/DC	042 319	x	
				230/50	041 366	x	
				024/DC	042 319	x	
				230/50	041 366	x	
				024/DC	042 319	x	
D 3/2-way valve NO 	8,0	1/4	0,95	0,5 - 16	024/DC	041 367	x
					024/50	041 368	x
					230/50	041 371	x
					230/50	041 386	x
					024/DC	041 374	x
					024/50	041 375	x
	12	3/8	2,3	0,5 - 16	230/50	041 380	x
					024/DC	x	x
					024/50	x	x
					110/50	x	x
					230/50	x	x
					024/DC	x	x
20	3/4	6,6	0,5 - 16	024/DC	x	x	
				024/50	x	x	
				110/50	x	x	
				230/50	x	x	
				024/DC	x	x	
				110/50	x	x	
25	1	10,0	0,5 - 10	024/DC	x	x	
				110/50	x	x	
				230/50	x	x	
				024/DC	x	x	
				110/50	x	x	
				230/50	x	x	
40	1 1/2	24,0	0,5 - 10	024/DC	x	x	
				230/50	x	x	

Ordering charts - impulse version (other versions on request)

All valves with manual override, brass body, NBR seal and cable plug

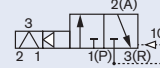
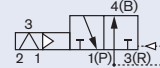
Circuit functions	Orifice [mm]	Port connection G or NPT	Kv value water P→A [m³/h]	Pressure range [bar]	Voltage/Frequency [V/Hz] ¹⁾	Item no. G	Item no. NPT
C 3/2-way valve NC 	8,0	1/4	0,95	0,5 - 16	024/DC	042 016	x
	12	1/2	2,6	0,5 - 16	024/DC	044 216	x
	20	3/4	6,6	0,5 - 10	024/DC	x	x
	40	1 1/2	24,0	0,5 - 10	024/DC	x	x
D 3/2 way valve, NO 	8,0	1/4	0,95	0,5 - 16	024/DC	122 805	x
	12	1/2	2,6	0,5 - 16	024/DC	043 429	x
	20	3/4	6,6	0,5 - 10	024/DC	x	x
	40	1 1/2	24,0	0,5 - 10	024/DC	x	x

¹⁾ Further voltages on request

x Article variant available, order number upon request

Ordering charts - explosion proofed versions (other versions on request)

 All valves with manual actuation, brass body, NBR seals and cable outlet 3 m ¹⁾

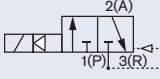
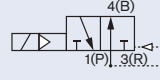
Circuit functions	Orifice [mm]	Port connection G or NPT	Kv value water P→A [m ³ /h]	Pressure range [bar]	Voltage/ Frequency [V/Hz] UC	Item no. G	Item no. NPT
C A 3/2-way valve NC 	8,0	1/4	0,95	0,5 - 16	24/DC	x	x
					110-120/60	x	x
					220-240/50	x	x
	12	3/8	2,3	0,5 - 16	24/DC	x	x
					110-120/60	x	x
					220-240/50	x	x
					24/DC	x	x
					110-120/60	x	x
					220-240/50	x	x
	20	3/4	6,6	0,5 - 16	24/DC	x	x
					110-120/60	x	x
					220-240/50	x	x
25	1	10,0	0,5 - 10	24/DC	x	x	
				110-120/60	x	x	
				220-240/50	x	x	
D 3/2-way valve NO 	8,0	1/4	0,95	0,5 - 16	24/DC	x	x
					110-120/60	x	x
					220-240/50	x	x
	12	1/2	2,6	0,5 - 16	24/DC	x	x
					110-120/60	x	x
					220-240/50	x	x
	20	3/4	6,6	0,5 - 16	24/DC	x	x
					110-120/60	x	x
					220-240/50	x	x
	25	1	10,0	0,5 - 10	24/DC	x	x
					110-120/60	x	x
					220-240/50	x	x

¹⁾ Terminal connection version also available

x Article variant available, order number upon request